

APPLICATION

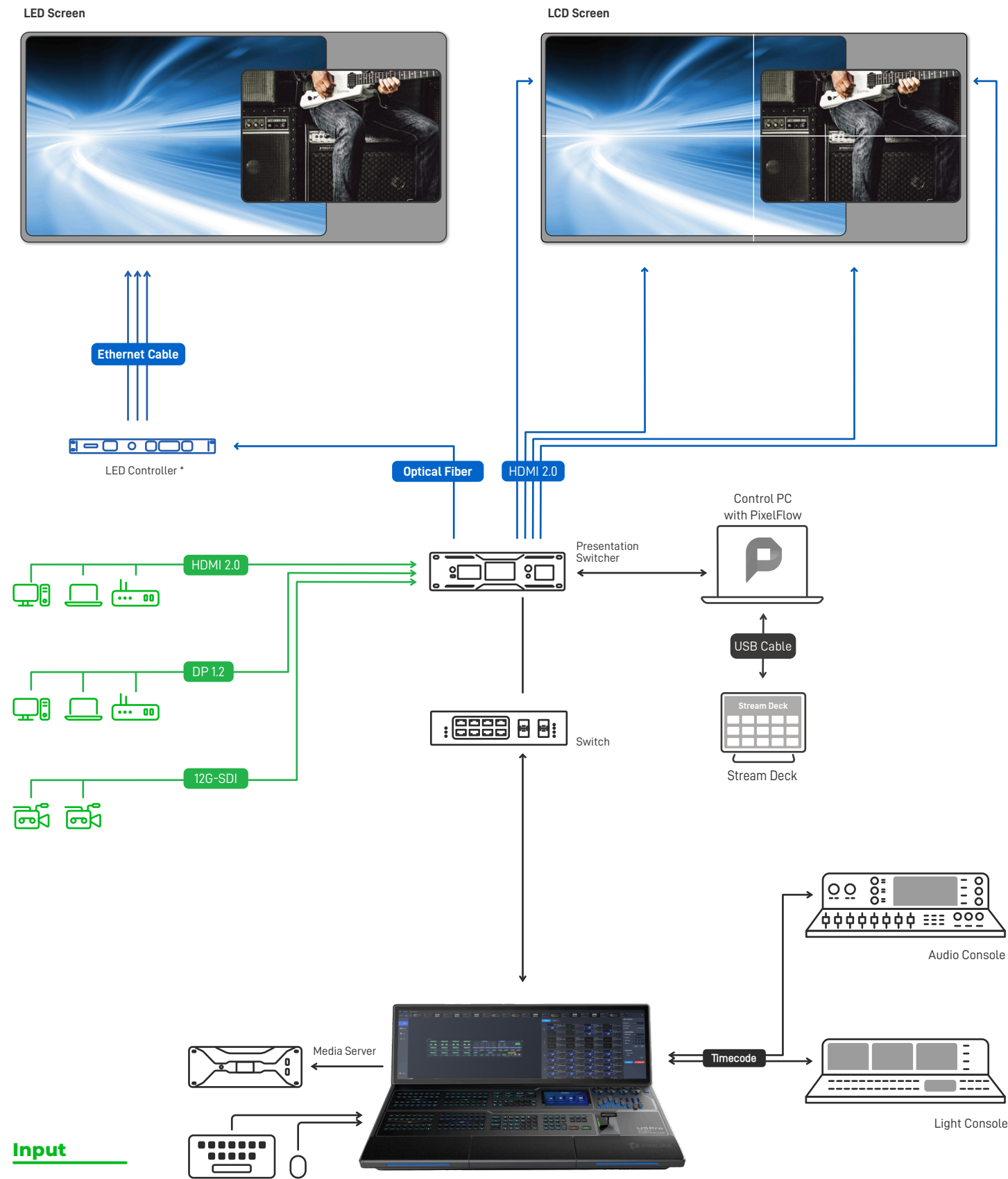

* Only LED controllers from NovaStar are supported for now.

Dimensions

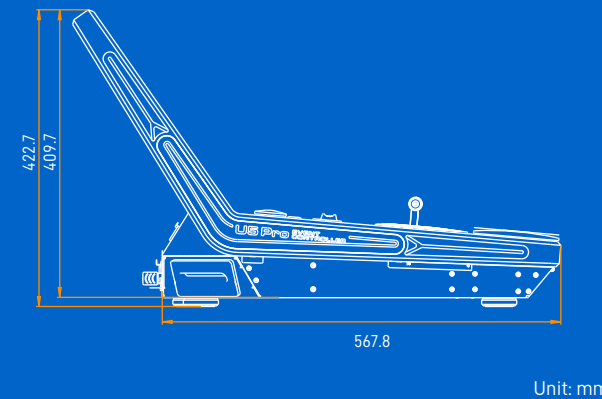
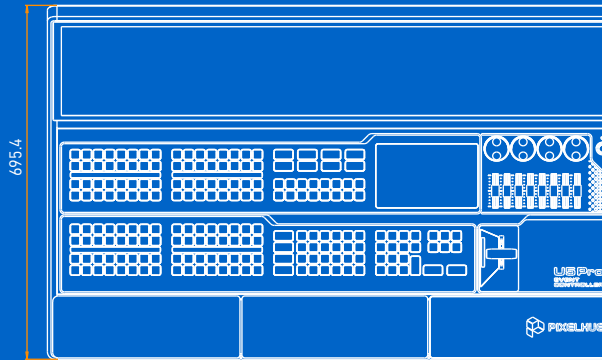
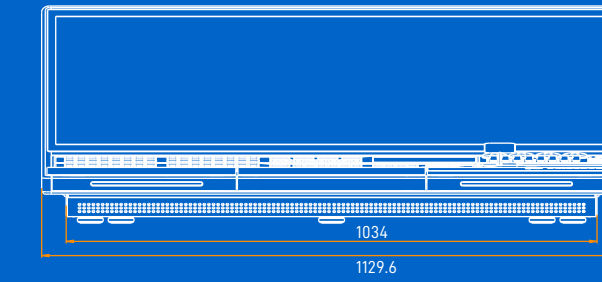

Unit: mm

Specifications

Dimensions (With handles, rack ears & rack mount)

W 1129.6 mm × D 695.4 mm × H 422.7 mm
W 44.47 × D 27.38 × H 16.64 inches
Please refer to the dimension diagram for more details

Product Weight

46 kg (Net weight)
107 kg (With accessories and flight case)

Noise on Average (@1, 0.75m height)

40 dB

Electrical Parameters

Power connector: AC100–240V~, 6A, 50/60Hz
Max power consumption: 330 W

Operating Conditions

Operating Environment:
• Temperature: 0°C to 50°C (32°F to 122°F)
• Humidity: 0% RH to 80% RH, non-condensing
Storage Environment:
• Temperature: -20°C to +60°C (-4°F to +140°F)
• Humidity: 0% RH to 95% RH, non-condensing

Safety Compliance

CE, FCC, IC

Packing Information

- 2x Optional Power Cable
- 2x HDMI Cable Male to Male, 3m
- 1x Cat5e Ethernet Cable_P-CAT5, 3m
- 1x USB Type-B to Type-A, 3m
- 1x Flight Case
- 1x Dust Cover
- 1x USB Drive
- 2x Gooseneck Lamp
- 1x Quick Start Guide
- 1x Customer Letter
- 1x Safety Manual
- 1x Certificate of Approval

Note:

Specifications subject to change without prior notice.

U5 Pro_EN_2024-07-29



PIXELHUE

www.pixelhue.com
info@pixelhue.com
1201A, 8 Caihefang Road, Haidian District, Beijing, China



PIXELHUE

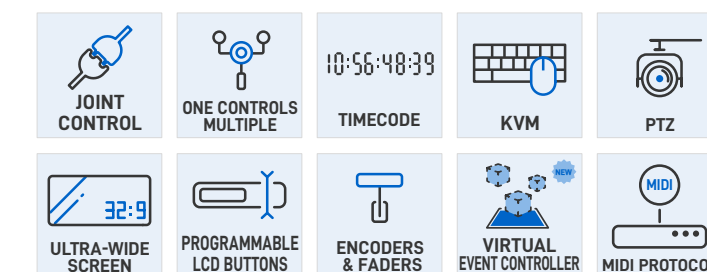

U5 Pro

Large-Scale
Event Controller

This datasheet includes features up to V1.4.1.

U5 Pro

Large-Scale
Event Controller

The U5 Pro is a large-scale event controller developed by PIXELHUE. Compared to its predecessor, the U5 Pro features more innovative design highlights and more powerful and friendly operation and control experience in the field, which will further facilitate your events today, such as large-scale interactive live events or shows, music tours, immersive art exhibitions, and more.

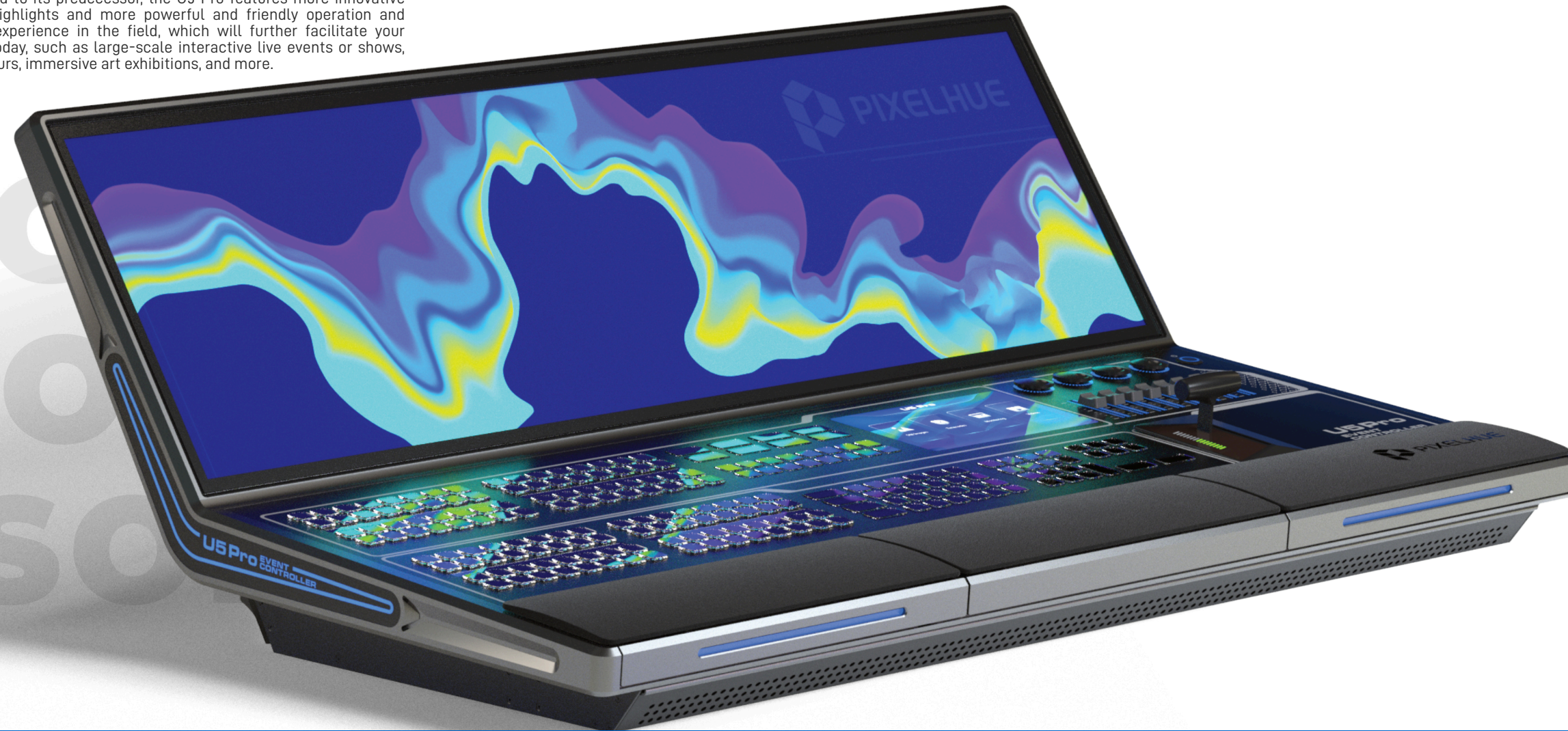

APPEARANCE



Ultrawide screen is designed for ultimate visualized operations. Multiple graphical user interfaces can be displayed on one screen, which also greatly simplifies the on-site deployment.



User-programmable LCD function buttons satisfy all your operation requirements. Function names, pages and more can be clearly shown on the buttons, and the button skins and styles can be customized as you wish.

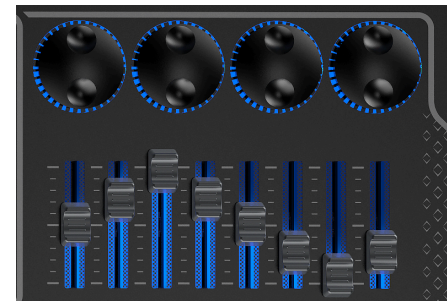

Four encoders and eight faders make the event operations amazingly convenient. Also, the encoders and faders can be bound with external MIDI functions for volume adjustment and more.



Abundant standard I/O connectors are provided on the rear panel to help you connect all necessary devices at ease.

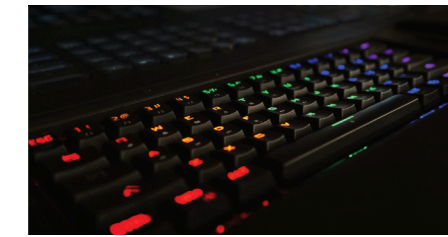

A built-in keyboard is provided to further facilitate your operations in the field; two drawers are designed to satisfy the storage needs in the event scenarios.



Maintainable and gas strut design makes regular maintenance possible and easier.

REMARKABLE EVENT CONTROL EXPERIENCE

Equipped with the state-of-the-art core architecture and SSD(NVMe), the U5 Pro event controller enables the most fluent and fast operations. With the design concept of increasing operational efficiency and satisfying the various changing needs that may arise from event scenarios, the U5 Pro event controller comes with all the crucial functionalities that you may need. The newly-upgraded built-in software PixelFlow with always user-friendly GUI helps you manage devices, screens, layers, sources, presets more stably and easily. The magnificent interactive design maximizes user convenience and shortens your learning curve. Convenient control over multiple presentation switchers and media servers greatly simplifies your on-site deployment and brings more convenience and ease to your events. In addition, timecode generating and accepting support, timecode format conversion ability and MIDI support add more extra value to all events.

DISTINCTIVE DESIGN, BORN FOR MEGA-EVENTS

The U5 Pro event controller comes with a ruggedized housing, 203 user-programmable LCD buttons, four encoders and eight faders, a high-resolution T-bar, etc. to bring you the maximum ease of use for your events. What's more, the unique design of 43.8" ultrawide Main Touchscreen and 8" Smart Touchscreen enables the most visualized and convenient operations. A built-in keyboard that comes with the event controller further facilitates your on-site use and two drawers are provided for possible storage purposes. All these make it the perfect solution for various spectacular events.

EASY AND CONVENIENT VIRTUAL EVENT CONTROLLER

All physical components of the event controller—including buttons, sliders, encoders, faders, and the T-bar—are virtualized within PixelFlow,

mirroring the purposes of these components. This allows users to customize the functionality of these components and enables their use. In addition, settings for virtual buttons and layouts can be configured in advance and quickly imported for on-site use. This feature greatly boosts operational flexibility, intuitiveness, and efficiency, minimizes space requirements, and ensures that users can enjoy a straightforward and convenient experience wherever they are.

FEATURES

- 43.8" Main Touchscreen and 8" Smart Touchscreen for visualized and convenient operations
- Smart Touchscreen for displaying still images, timecode, device health and Multiviewer
- 4x encoders and 8x faders, configurable as internal software function buttons or as MIDI buttons
- User-programmable LCD indication buttons for names, pages and more
- Free replacement of button skins and styles
- Built-in upgraded software PixelFlow with more user-friendly GUI, shorter learning curve

A comprehensive simulator for all event controller components in PixelFlow on the control PC, including buttons, encoders, faders, and the T-bar, which replicates the functionality of physical buttons and enables their use

Customization of physical and virtual event controllers: Tailor button functions and layouts to your preference, and save the layouts as configuration files to easily transfer settings across different PCs and controllers

- Timecode generating, receiving and conversion abilities; LTC, MTC and MIDI USB timecode formats support
- Simultaneous control over multiple switchers and media servers
- Control over third-party devices via MIDI protocol
- Servable as a MIDI keyboard where all buttons support the MIDI protocol and feature a global MIDI switch
- Customizing MIDI button parameters, including type, channel, key position, key value and output on/off on the physical event controller
- KVM function
- PTZ control
- High anticorrosive aluminum housing
- Built-in keyboard and two extra drawers
- Unique design for convenient disassembly and easy maintenance

